

## Data sheet

# Full bore ball valves (PN 16/25/40)

### Description



Danfoss full bore ball valves are shut off valves developed for District Heating and District Cooling networks, with circulating medium.

It is a range of steel ball valves with fully welded body.

The valve design makes them ideal for building installation due to:

- optimized flow design in the valve.  
This means increased capacity, reduced flow resistance and thus lower pump energy cost;

- optimal tightness and long lifetime due to design and material selection in ball seal and stem seal (Carbon reinforced PTFE);
- the valves are maintenance free, besides the shut off valves in the core distribution network Danfoss offers a range of supplementary valves, e.g. hot tap valves, branching valves, house insertions and twin valves.

#### Main data:

- DN 15-400
- $k_{vs} = 25-37.500 \text{ m}^3/\text{h}$
- PN 16, 25, 40
- Temperature: 0 ... 180 °C
- Medium:  
Circulation water / glycolic water up to 50%
- Min. storage and transport temperature: -40 °C

#### Approvals and norms:

- 100 % final inspection. Leak and shell test as well as dimension and functionality test is performed on each and every valve according to applicable standard (EN 12266 part 1 P10-P11-P12 & part 2 F20).
- PED Directive 97/23/EEC Modul H1
- Danfoss A/S is certified according to ISO 9001
- Furthermore certified according to ISO 14001 and OHSAS 18001.

**Ordering**  
JIP-WW welding  
JIP-FF flange

Type WW			Type FF		
DN [mm]	Code No. PN25	Code No. PN40	Code No. PN16	Code No. PN25	Code No. PN40
15	See table PN40 to the right	065N0100	See table PN40 to the right	See table PN40 to the right	065N0300
20		065N1105			065N1305
25		065N1110			065N1310
32		065N1115			065N1315
40		065N1120			065N1320
50	065N1125	065N1325			
65	065N1130	X	065N1230	065N1330	X
80	065N1135		065N1235	065N1335	
100	065N1740		065N1840	065N1940	
125	065N1745		065N1845	065N1945	
150	065N1751		065N1851	065N1950	

DN [mm]	Code No. WW PN25		Code No. FF PN16		Code No. FF PN25	
	Valve with worm gear	Valve with gear flange	Valve with worm gear	Valve with gear flange	Valve with worm gear	Valve with gear flange
150	065N1151	065N1152	065N1251	065N1252	065N1351	065N1352
200	065N1156	065N1157	065N1256	065N1257	065N1356	065N1357
250	065N1161	065N1162	065N1261	065N1262	065N1361	065N1362
300	065N1166	065N1167	065N1266	065N1267	065N1366	065N1367
400	065N1176	065N1177	065N1276	065N1277	065N1376	065N1377

JIP-FW flange/welding

Type FW			
DN [mm]	Code No. PN16	Code No. PN25	Code No. PN40
15	See table PN40 to the right	See table PN40 to the right	065N0700
20			065N1705
25			065N1710
32			065N1715
40			065N1720
50	065N1725		
65	065N1530	065N1630	X
80	065N1535	065N1635	
100	065N1955	065N1970	
125	065N1961	065N1975	
150	065N1965	065N1981	

DN [mm]	Code No. FW PN16		Code No. FW PN25	
	Valve with worm gear	Valve with gear flange	Valve with worm gear	Valve with gear flange
150	065N1551	065N1552	065N1651	065N1652
200	065N1556	065N1557	065N1656	065N1657
250	065N1561	065N1562	065N1661	065N1662
300	065N1566	065N1567	065N1666	065N1667
400	065N1576	065N1577	065N1676	065N1677

**Ordering (continuous)**

 JIP-II internal thread  
 JIP-IW internal thread/welding

DN [mm]	Code No.	
	PN 40	PN 40
	20	065N1805
25	065N1810	065N1910
32	065N1815	065N1915
40	065N1820	065N1920
50	065N1825	065N1925

**Actuators**

DN [mm]	Code No.	
	Auma NORM	Auma MATIC
50-65	065N8199	065N8399
80	065N8200	065N8400
100-150	065N8205	065N8405
200	065N8220	065N8420
250	065N8225	065N8425
300	065N8235	065N8435
400	065N8240	065N8440

**Worm gear**

Description	Code No.	
	Worm gear	Position indicator with end switch
Worm gear for DN 100/125/150 full bore	065N8115	065N8074
Worm gear for DN 200 full bore	065N8120	065N8077
Worm gear for DN 250 full bore	065N8125	065N8082
Worm gear for DN 300 full bore	065N8135	065N8113
Worm gear for DN 400 full bore	065N8140	065N8136

Technical data

DN	mm	15	20	25	32	40	50	65	80	100	125	150	200	250	300	400	
$k_{vs}$	m <sup>3</sup> /h	25	50	90	160	235	395	820	1.100	2.300	3.700	6.100	11.000	17.500	24.000	37.500	
PN		16/25/40						16/25									
Temp range		0-180 °C															
Medium		Circulation water / glycolic water up to 50 %															
<b>Material</b>																	
Shell (Valve body)		Weldable steel <sup>1)</sup> e.g. P235GH / Mat. no. 1.0345															
Stem		Stainless steel e.g. X2CrNi19-11 (EN10272) / Mat. no. 1.4306															
Ball		Stainless steel e.g. X5CrNi18-10 (EN10088) / Mat. no. 1.4301															
Seat rings		Carbon reinforced PTFE															
Stem sealings		Carbon reinforced PTFE															
Gear box		Cast iron with stainless steel trim															
Flanges		EN1092-1 Mat No. 3E0 e.g. P245GH / Mat. no. 1.0352															

<sup>1)</sup> Meeting the requirements of the PED.

Pressure drop/velocity diagram

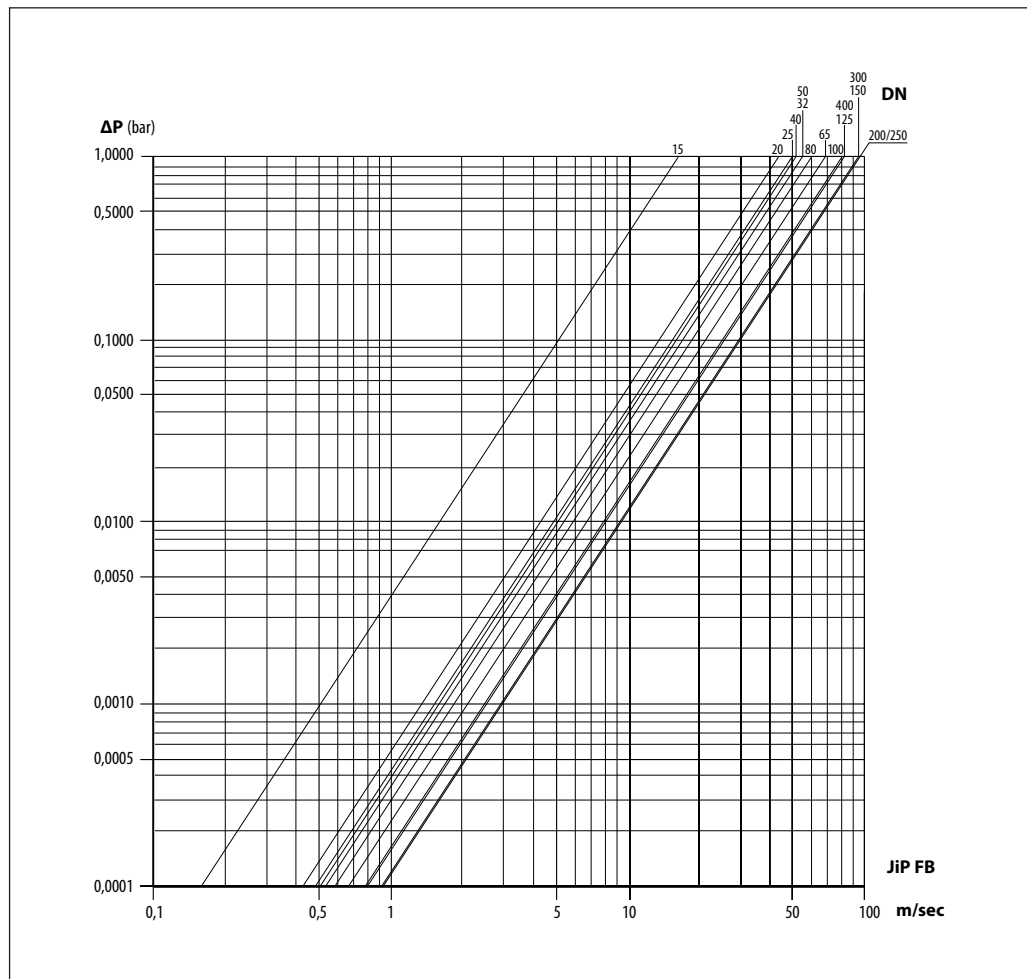

Pressure drop/flow diagram

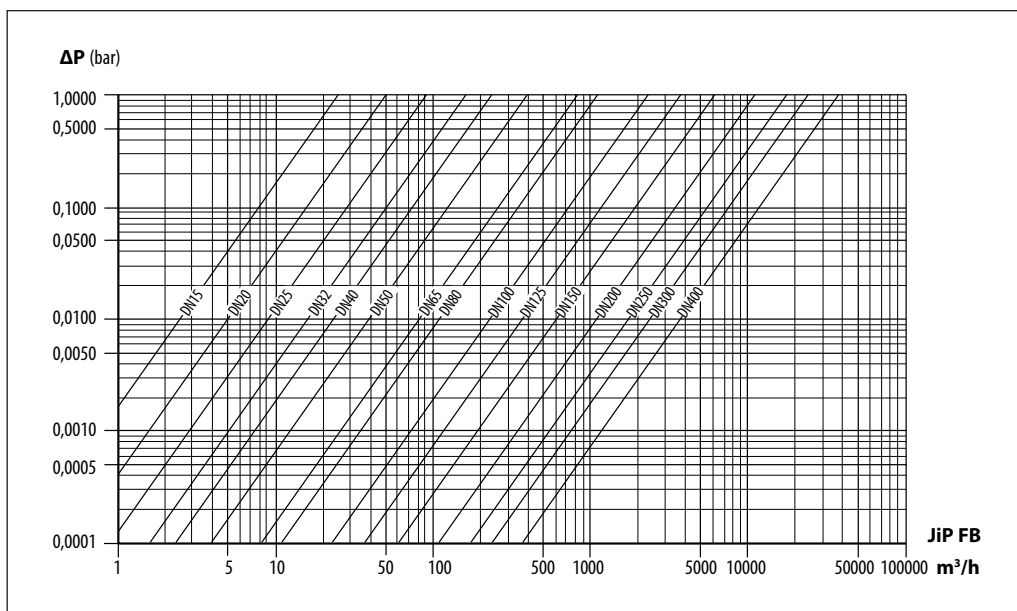

Pressure/temperature diagram

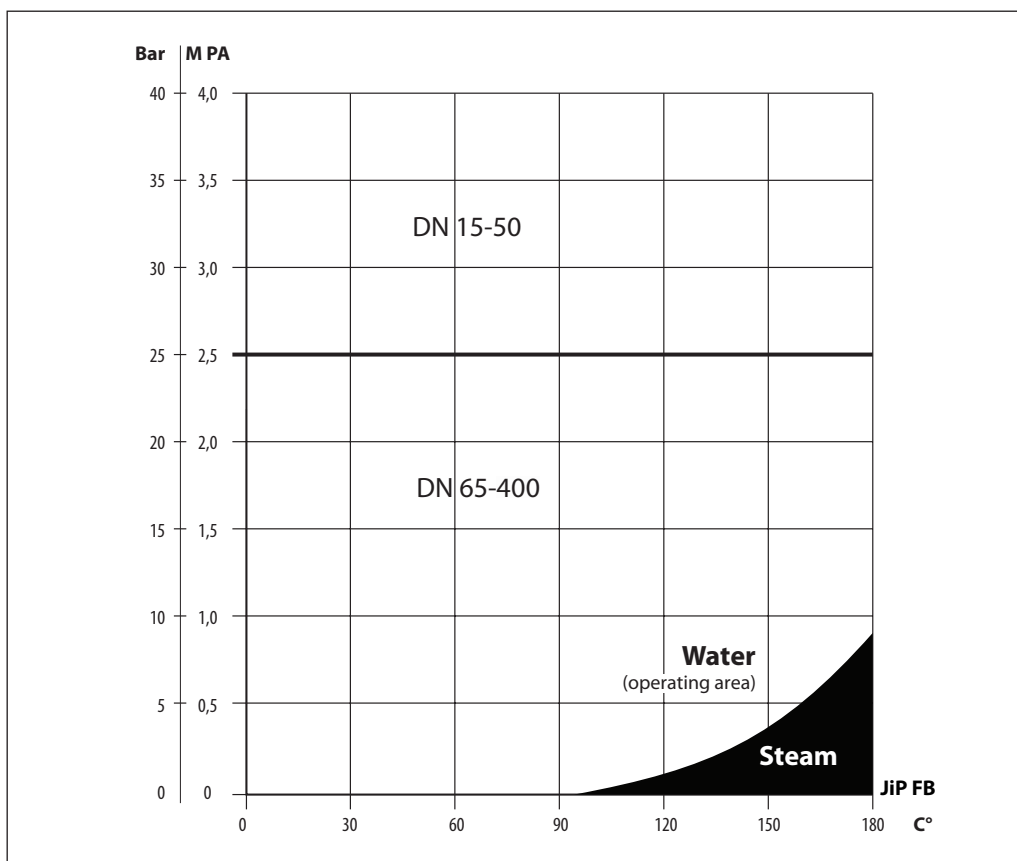

Dimension  
JIP WW welding

DN [mm]	ØA	t	ØB	ØD	L	H	Hh	Hg	E	F	ØC	S	O	G1	G2	G3
<b>PN 40</b>																
15	42,4	2,6	21,3	15	230	125	X	X	X	58	24,5	115	X	X	X	X
20	48,3	2,6	26,9	20	220	125				60	24,5	115				
25	60,3	2,6	33,7	25	240	130				61	24,5	115				
32	76,1	2,6	42,4	32	270	170				90	35	157				
40	88,9	2,6	48,3	40	275	175				92	35	157				
50	114,3	2,9	60,3	50	320	190				108	45	205				
<b>PN 25</b>																
65	133	2,9	76,1	65	280	210	-	-	135	113	49	257	X	X	X	X
80	159	3,2	88,9	80	360	225	-	-	145	120	49	257				
100	193,7	3,6	114,3	100	315	245	-	-	165	136	60	360				
125	219,1	4	139,7	125	355	295	-	-	205	146	60	655				
150	273	4,5	168,3	150	375	315	385	325	240	152	60	655				
200	355,6	6,3	219,1	200	485	-	585	430	340	209	87	-	400	330	100	244
250	457	6,3	273	250	595	-	635	500	400	225	100	-	400	397	141	329
300	521	8	323,9	300	740	-	690	556	480	258	139,7	-	400	429	150	336
400	711	8,8	406,4	400	1030	-	855	668	690	322	168,3	-	500	460	188	410

VDN 200-400 - dimensions and weight are incl. worm gear

Dimension (continuous)  
JIP FF flanged

DN [mm]	ØA	ØD	H	Hh	Hg	E	F	ØC	S	O	G1	G2	G3	L	DF	I	L	DF	I			
<b>PN 40</b>																						
15	42,4	15	125	X	X	X	58	24,5	115	X	X	X	X	X	X	X	130	95	23			
20	48,3	20	125				60	24,5	115								150	105	21			
25	60,3	25	130				61	24,5	115								160	115	20			
32	76,1	32	170				90	35	157								180	140	40			
40	88,9	40	175				92	35	157								200	150	41			
50	114,3	50	190				108	45	205								230	165	56			
<b>PN 16 / 25</b>																						
65	133	65	210	-	-	135	113	49	257	X	X	X	X	X	X	X	290	185	59	290	185	59
80	159	80	225	-	-	145	120	49	257								370	200	64	310	200	64
100	193,7	100	245	-	-	165	136	60	360								325	220	83	325	235	76
125	219,1	125	295	-	-	205	146	60	655								365	250	91	490	270	81
150	273	150	315	385	325	240	152	60	655	200	257	75	190	385	285	94	510	300	86			
200	355,6	200	-	585	430	340	209	87	-	400	330	100	244	495	340	148	635	360	138			
250	457	250	-	635	500	400	225	100	-	400	397	141	329	720	405	158	720	425	149			
300	521	300	-	690	556	480	258	139,7	-	400	429	150	336	835	460	190	835	485	178			
400	711	400	-	885	668	690	322	168,3	-	500	460	188	410	1100	580	235	1100	620	215			

DN 200-400 - dimensions are incl. worm gear

Dimension (continuous)  
JIP FW flanged/welding

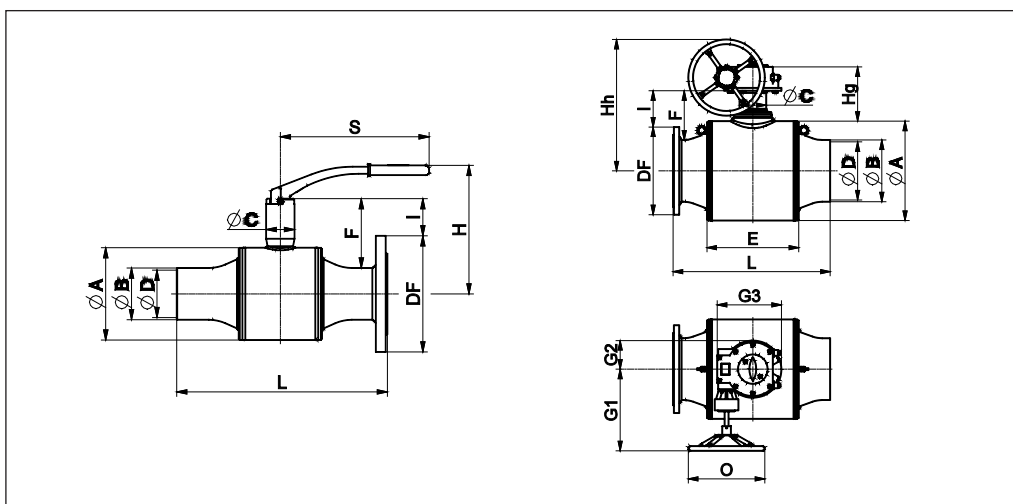

DN [mm]	ØA	ØD	H	Hh	Hg	E	F	ØC	S	O	G1	G2	G3	L	DF	I	L	DF	I			
	PN 40													PN 16			PN 40					
15	42,4	15	125	X	X	X	58	24,5	115	X	X	X	X	X	X	X	180	95	23			
20	48,3	20	125				60	24,5	115								185	105	21			
25	60,3	25	130				61	24,5	115								200	115	20			
32	76,1	32	170				90	35	157								230	140	40			
40	88,9	40	175				92	35	157								235	150	41			
50	114,3	50	190	108	45	205	275	165	56													
	PN 16 / 25													PN 16			PN 25					
65	133	65	210	-	-	135	113	49	257	X	X	X	X	X	X	X	285	185	59	285	185	59
80	159	80	225	-	-	145	120	49	257								365	200	64	335	200	64
100	193,7	100	245	-	-	165	136	60	360								320	220	83	320	235	76
125	219,1	125	295	-	-	205	146	60	655								360	250	91	360	270	81
150	273	150	315	385	325	240	152	60	655								200	257	75	190	380	285
200	355,6	200	-	585	430	340	209	87	-	400	330	100	244	490	340	148	560	360	138			
250	457	250	-	635	500	400	225	100	-	400	397	141	329	705	405	158	705	425	149			
300	521	300	-	690	556	480	258	139,7	-	400	429	150	336	825	460	190	825	485	178			
400	711	400	-	885	668	690	322	168,3	-	500	460	188	410	1050	580	235	1050	620	215			

DN 200-400 - dimensions and weight are incl. worm gear - weight based on PN 40/25



**Dimension (continuous)**  
JIP-II internal thread

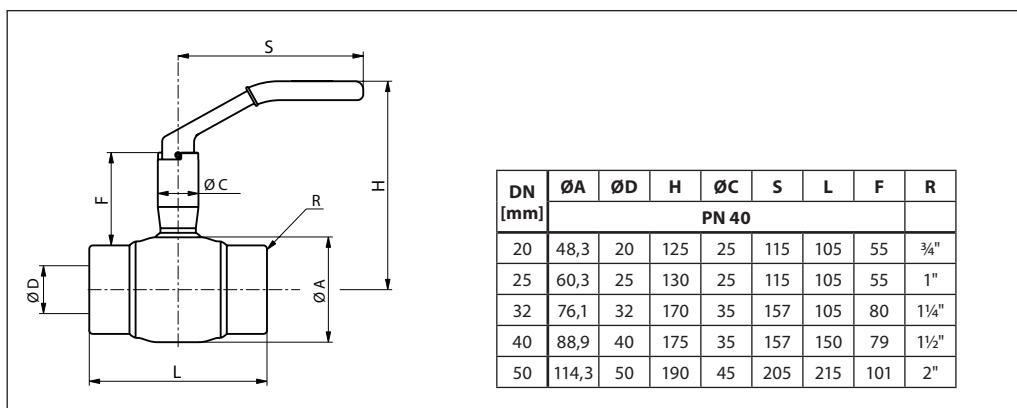

JIP-IW internal thread/welding

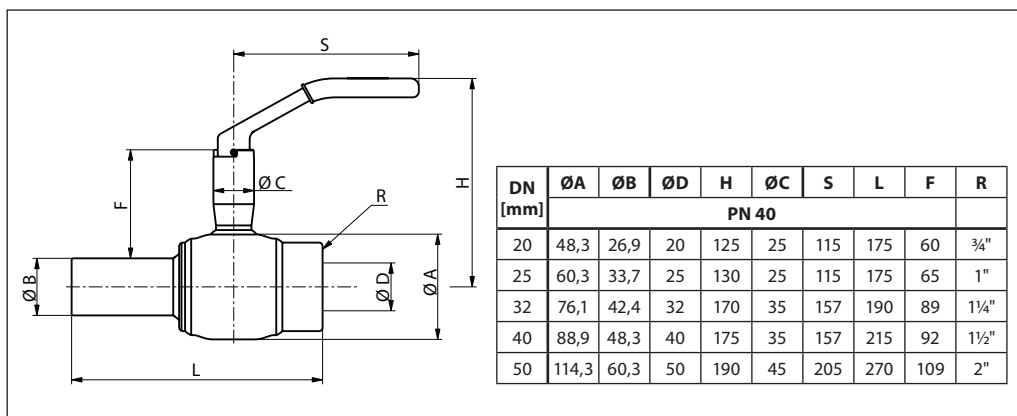

AUMA NORM electrical actuators for Danfoss ball valves

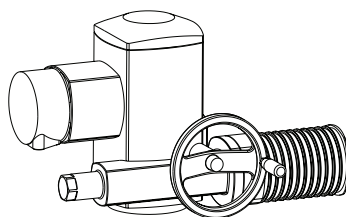

Danfoss ball valves		Auma Actuators	
DN [mm]	Type	Operating time for 90° turn [s]	
50-65	SG 05.1	16	
80	SG 07.1	32	
100-125-150	SG 10.1	32	
200-250	SA 7.6 (22) + GS 100.3 + VZ 4.3	142	
300	SA 10.2 (22) + GS 125.3 + VZ 4.3	142	
400	SA 10.2 (32) + GS 160.3 + GZ 160.3 i=8:1	207	

**Features:**

- 2 limit switches – opening / closing
- 2 torque switches - opening/ closing
- Heater
- Blinker switch for operating phase
- Manual operation with hand wheel
- Thermo switch

**Main Data:**

- Nominal voltage: 3×400 VAC, 50 Hz
- Grade of enclosure: - IP 67 (DN 50-150)  
- IP 68 (DN 200-400)
- Wiring diagram: - TP 110/001 (DN 50-150)  
- TPA 00R1AA-000 (DN 200-400)

The actuators can be equipped with various accessories.  
Control and regulating unit AUMA Matic in the basis design can be supplied.  
For other mains voltages than 3×400 V/50 Hz or additional questions please contact us.

When commissioning and under certain problematic system conditions, it can be necessary to choose slower actuators to avoid water hammering and oscillations.



